

Grosfillex® TN 28

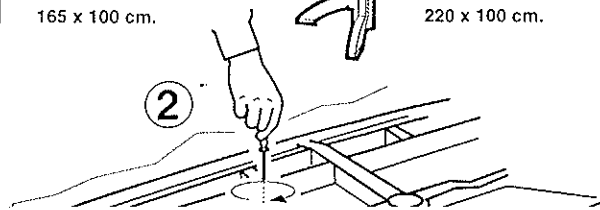

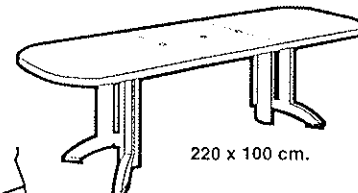

10

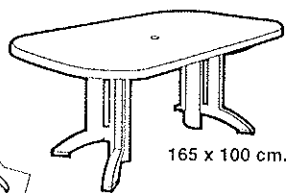
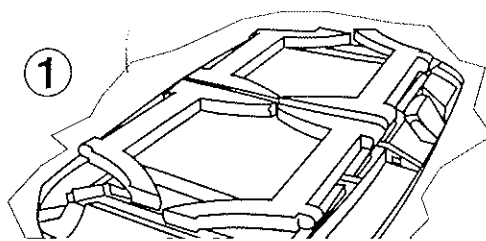
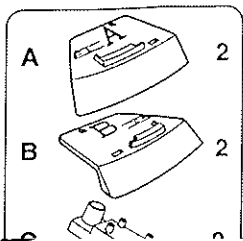
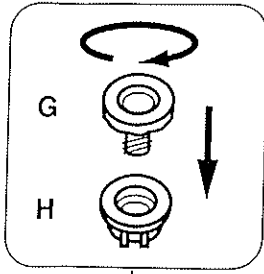
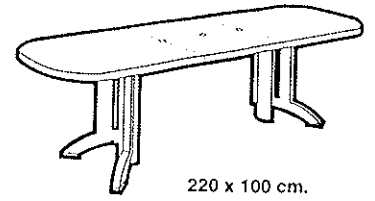
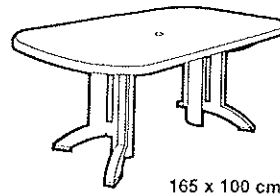
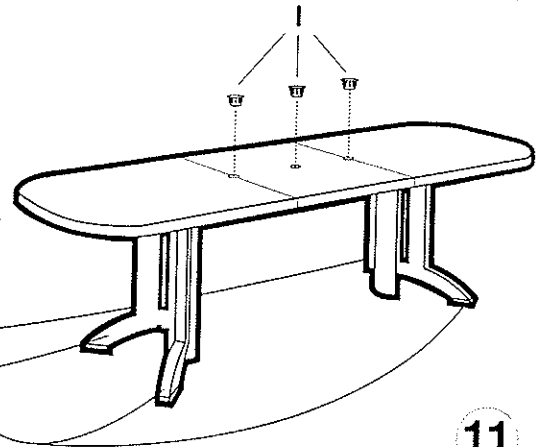
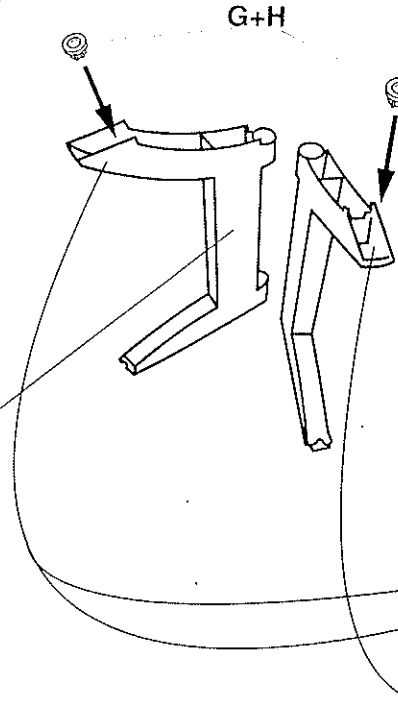
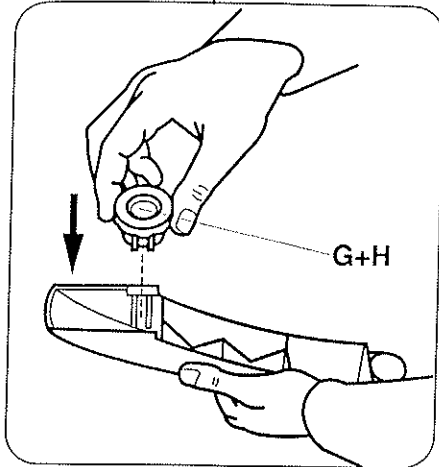

SOS C.V0161N.01100 BELLIQMAT

